

Single Wing STB POWER Line Acoustic Door

Noise Control **R_{w,P} 57 dB** **in accordance with DIN EN ISO 10140-2**

- | | | |
|--|--|--|
| <ul style="list-style-type: none"> * Shot Inhibiting * Air Tight * Rain and fire water tight * Pressure resistant * Explosion protection * Stainless steel | <p>FB4,FB6,FB7-NS
up to classification 4
Class. 6A
up to 18 kPa
up to zone 1/21</p> | <p>in accordance with DIN EN 1522
in accordance with DIN EN 1026
in accordance with DIN EN 1027
in acc. with DIN EN 1127-1 or ATEX 94/9/EG</p> |
|--|--|--|

Range of Dimensions: **Width from 500 mm to 1500 mm**
Height from 500 mm to 3250 mm
Oversizes upon request

(* special options see back of page)

Technical specification and text for invitation to tender

- | | |
|---------------------------------------|---|
| Product: | STB 57-1 single wing acoustic steel door brand Buchele
In accordance with DIN EN ISO 10140-2 |
| Door Type: | STB 57-1 POWER Line |
| Noise controll R_{w,P} | 57 dB |
| Dimensions: | x mm |
| Door Leaf: | Double walled, level 80 mm thick steel door leaf without hinge embossing, three sides folded with thick rebate and adjustable fixed sealing profile in the fold. Without bottom stop with duplex tow sealing system. Special insulating inserts completely laid in and glued. |
| Sill: | Threshold profile barrier-free hump sill. Surface galvanized welded to the frame. |
| Frame: | 3-sided circumferential folded corner frame with high-quality multi-chamber sealing profile adjustable fixed in the three sided groove. |
| Hinges: | Threepart height-adjustable construction hinges with hinge pin retention and ball-bearing spacer ring for smooth door movement. |
| Fitting: | Worm tension lock in a solid design with robust lock worm, shock mounted striker plate and automatic false control barrier (FB-barrier).
Lock prepared for installation of a profile cylinder supplied by customer.
Clamping lever in aluminium F1 enforced design ergonomic design, fixed rotatable on with square plate visible screwed to the door leaf. |
| Surface: | Door leaf and frame galvanized and primed with one component primer similar RAL 7001. |
| Mounting: | Delivery and professional assembly including filling of the cavities in the frame with mortar of group III. |

Special Models

Standard Glazing:	Duplex glazing held by profiled and visibly screwed steel glazing bars. Minimum frieze width 125 mm side and top, base 340 mm.
Bullet Proof:	FB4, FB6, FB 7-NS special inlay in door leaf and frame.
Airtight:	High-quality multi-chamber sealing profile adjustable fixed in the three sided groove of the frame in connection with a duplex tow sealing system or a stop seal.
Driving Rain Water tight:	High-quality multi-chamber sealing profile adjustable fixed in the three sided groove of the frame in connection with a duplex tow sealing system or a stop seal.
Stainless Steel:	Material 1.4301 (V2A) or. 1.4571 (V4A), Surface bright mill, brushed or mattet.
New:	Air Lock Soil Liner System (Pneumatic sealing system on the bottom). Automatic lowering or lifting of the bottom seal when operating the lever.

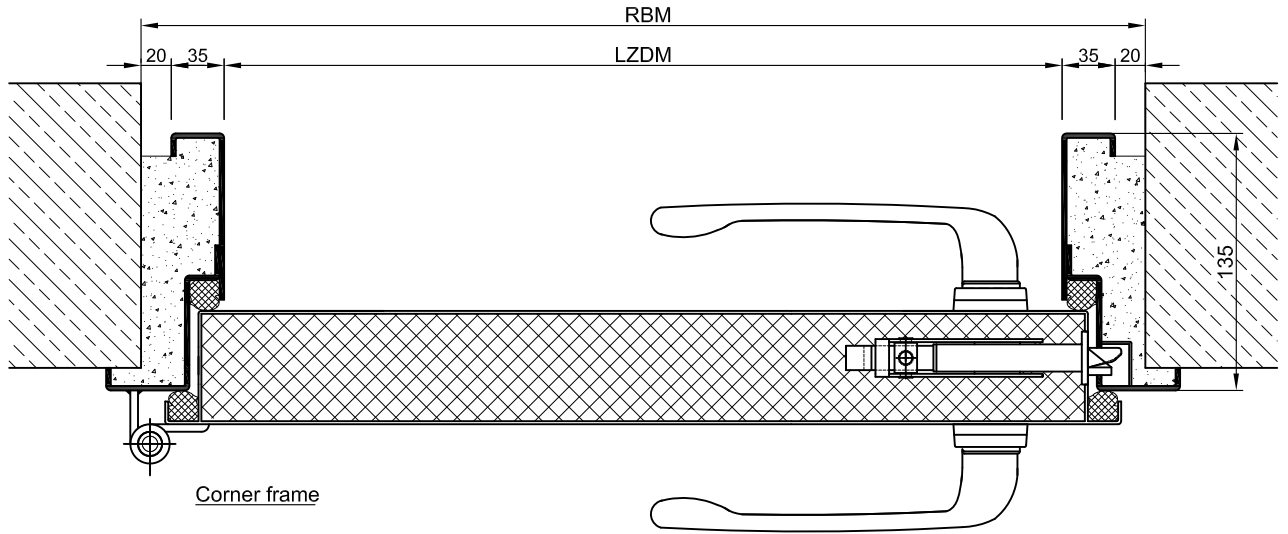

Corner frame

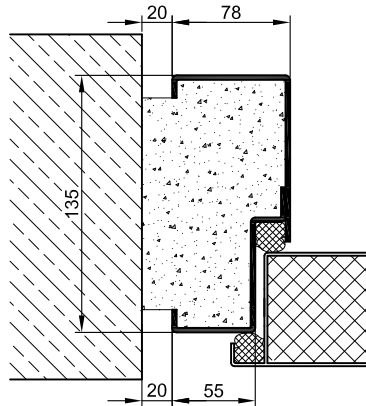
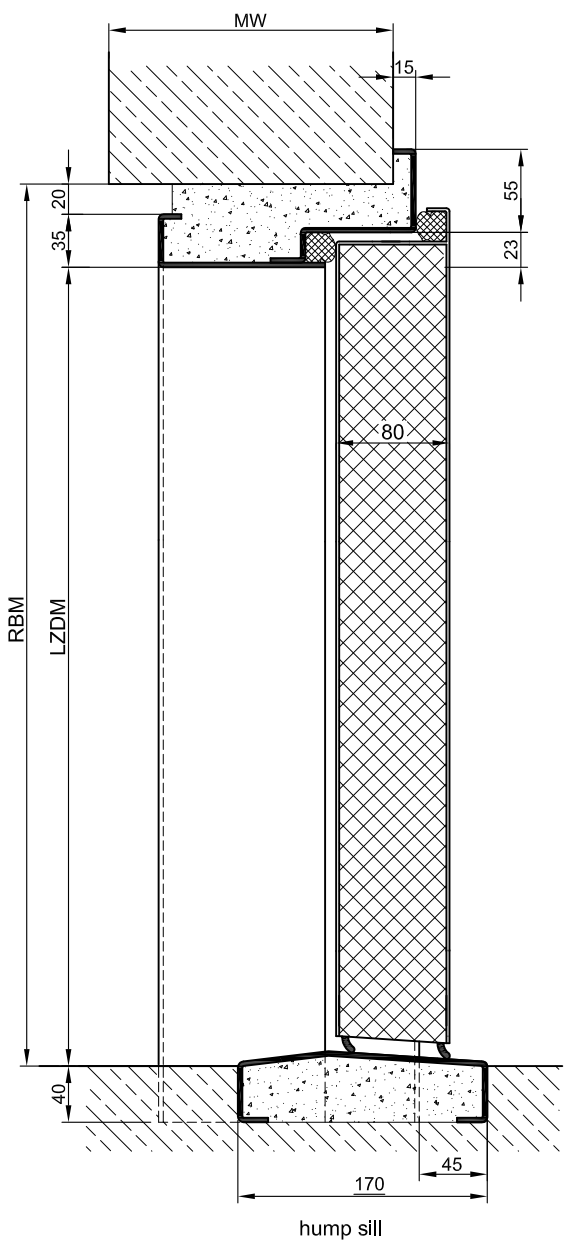

Block frame

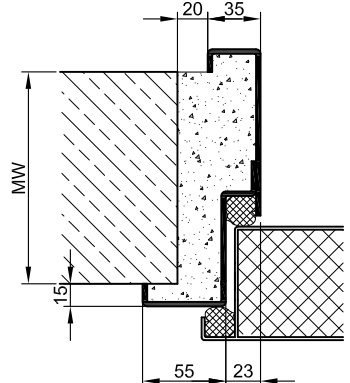

Encasing frame

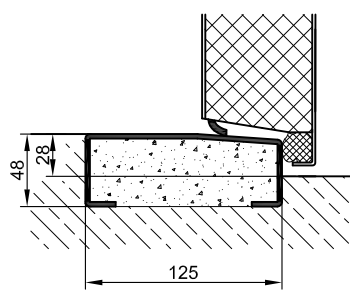
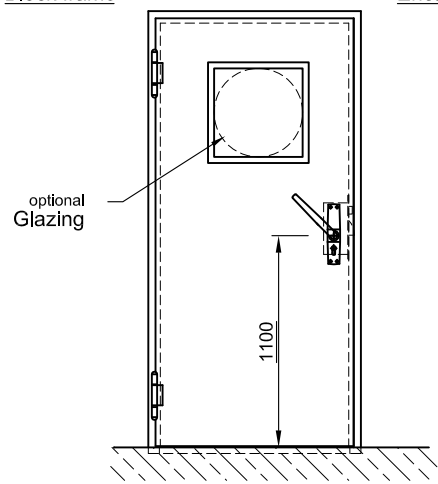

half sill

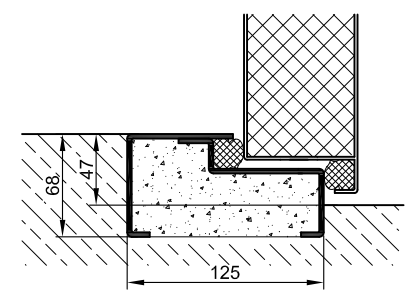

full sill